

Trampolín BALI

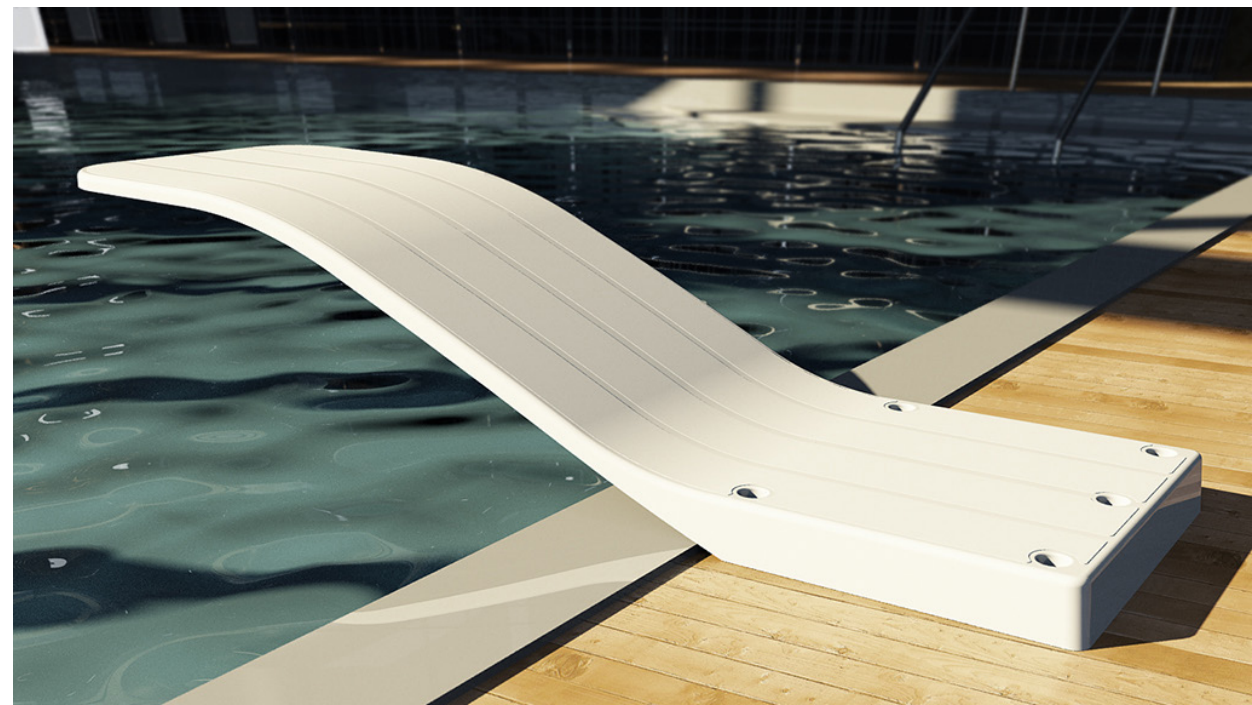

Packaging

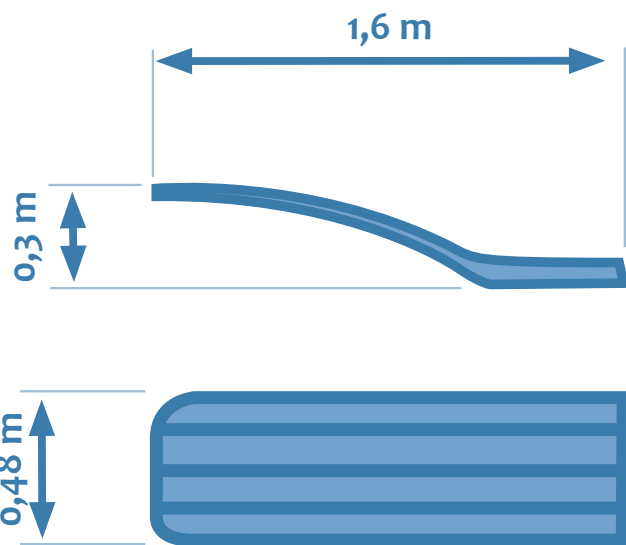
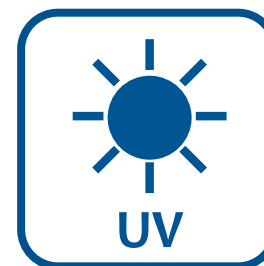
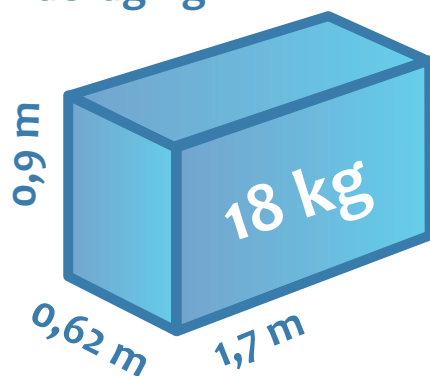

Trampolín de gran anchura fabricado en poliéster reforzado con fibra de vidrio. Cuenta con una superficie antideslizante y es apto tanto para piscinas públicas de uso recreativo como para piscinas privadas. Diseñado según la normativa EN 13451-10. Se suministra con anclajes.

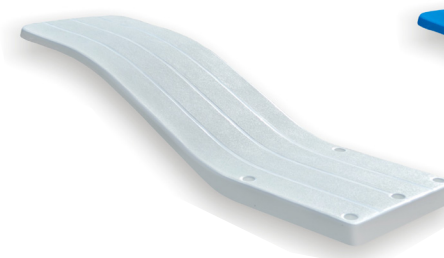

Blanco
RAL 9016

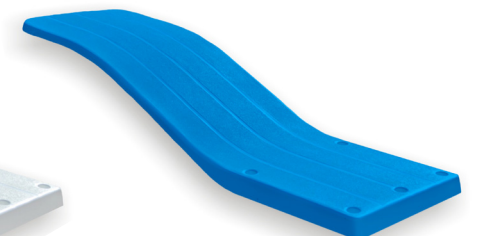

Azul
RAL 5015

Trampolín BALI

Dimensiones

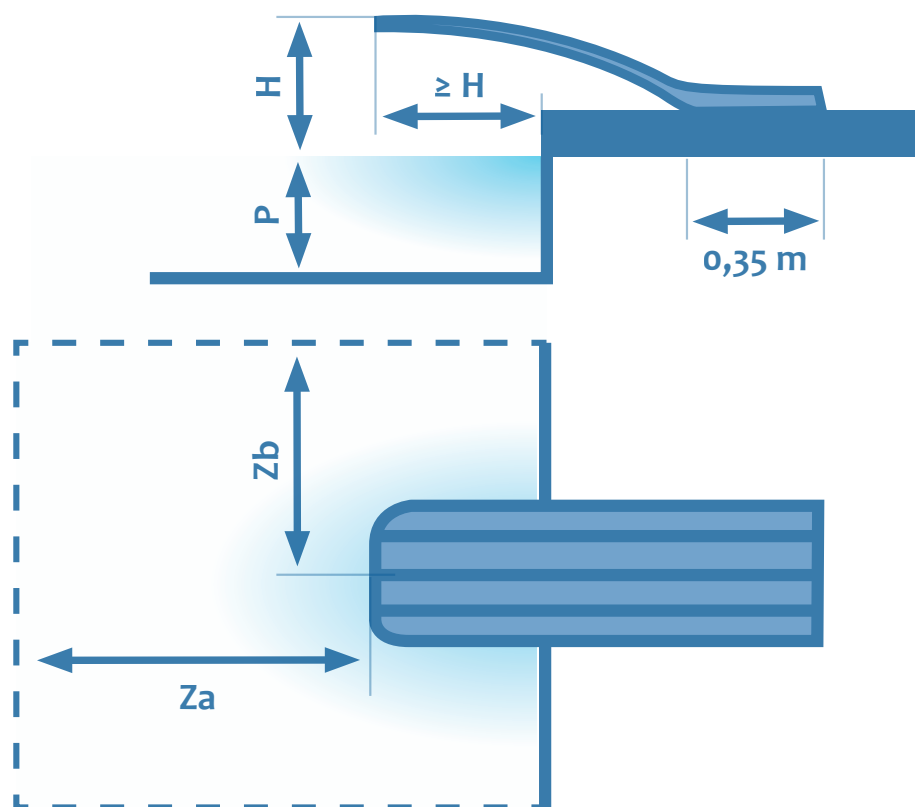

Cimentación e instalación

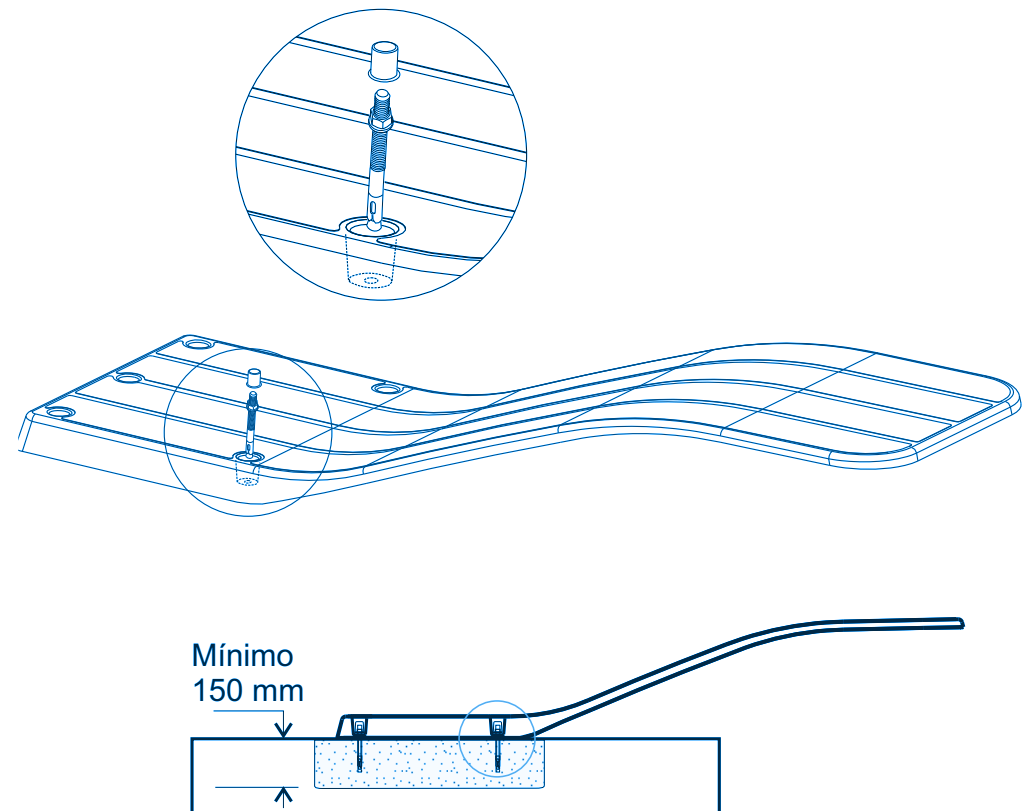

* La cimentación para la instalación debe cumplir como mínimo con las características del hormigón C20/25 según la norma ENV206.

Modelo	P	Za	Zb	H
Piscinas públicas * Norma EN-13451-10	3,4 m	9 m	2,5 m	< 1m
Piscinas privadas	2 m	7 m	2 m	< 1m

Trampolín BALI

Cimentación e instalación

